

THE JAGGER

High Security Palisade Panel

PRODUCT CODE :

ARD-3.0

MATERIAL :

3mm Roll Formed Steel
50 x 5 EA Rails

FINISH :

Hot Dip Galvanised

PANEL WEIGHT :

124 kg

FIXINGS SUPPLIED :

Palisade Bolts
Shear Nuts

RECOMMENDED POST :

Inground 3.8mH
75 SHS x 3mm

Flanged 3.0mH

75 SHS x 3mm

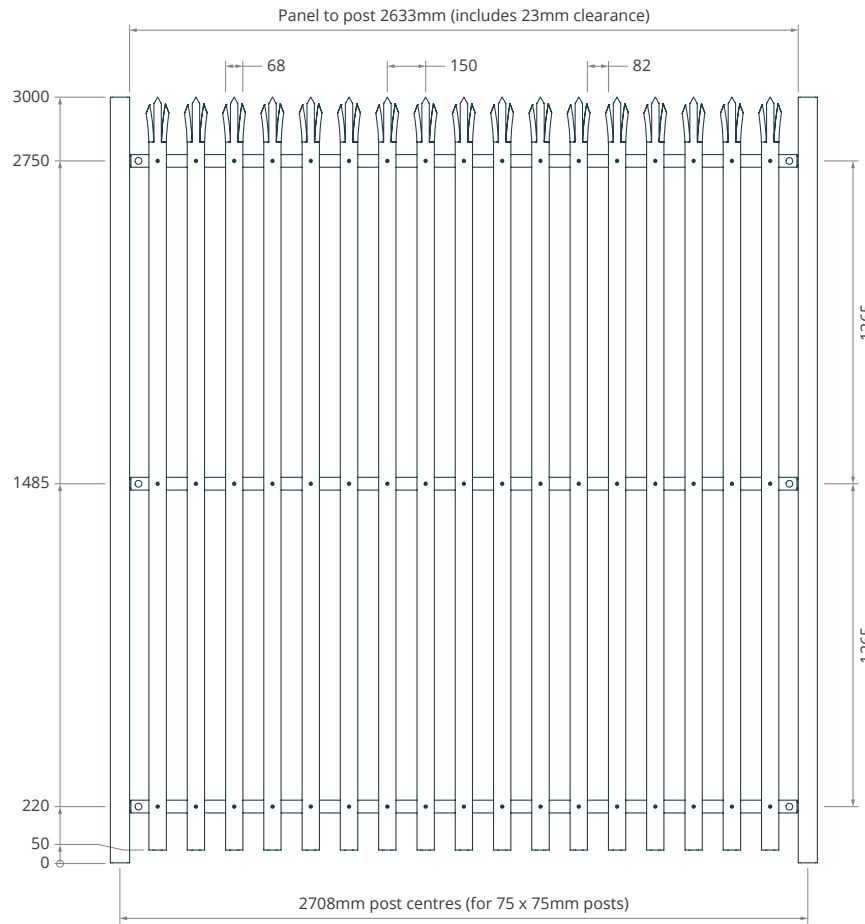

FLANGE POST

Fence Panel

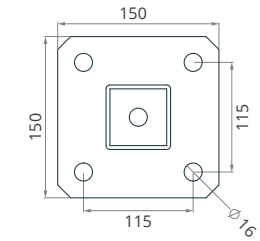

Post Size: SHS 75

Flange Thickness: 10mm

FIXINGS

M12x100 sleeve anchor

Huck bolt or
Shear nut and palisade bolt

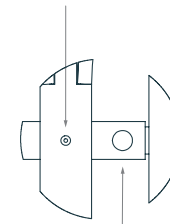

M12 x 30mm coach bolt
with shear nut

INGROUND POST

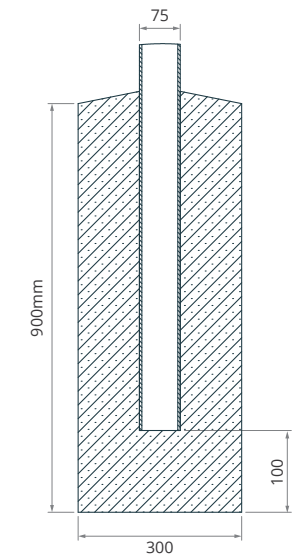

RAIL BRACKET

Bolt On

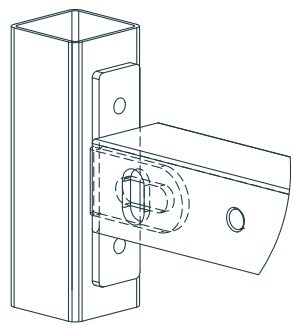

Weld On

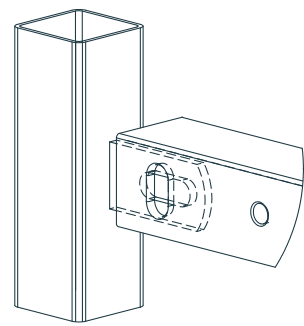

DETAILS

Trident Top

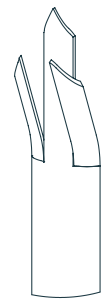

Spear Top

