

THE METALLICA

Anti-scale Welded Mesh Panel

PRODUCT CODE :

358DV-22x36

MATERIAL :

HDG Rigid Wire 4mm Dia

FINISH :

Hot Dip Galvanised

SHEET WEIGHT :

83 kg

FIXINGS SUPPLIED :

- Mesh Clips
- Security Screws
- Bolt on Brackets and Rails

RECOMMENDED POST :

Steel 100 SHS x 3.0mm

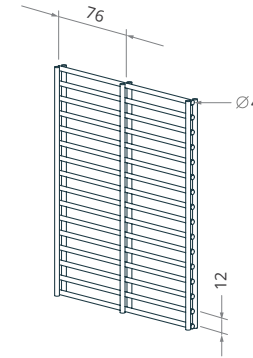
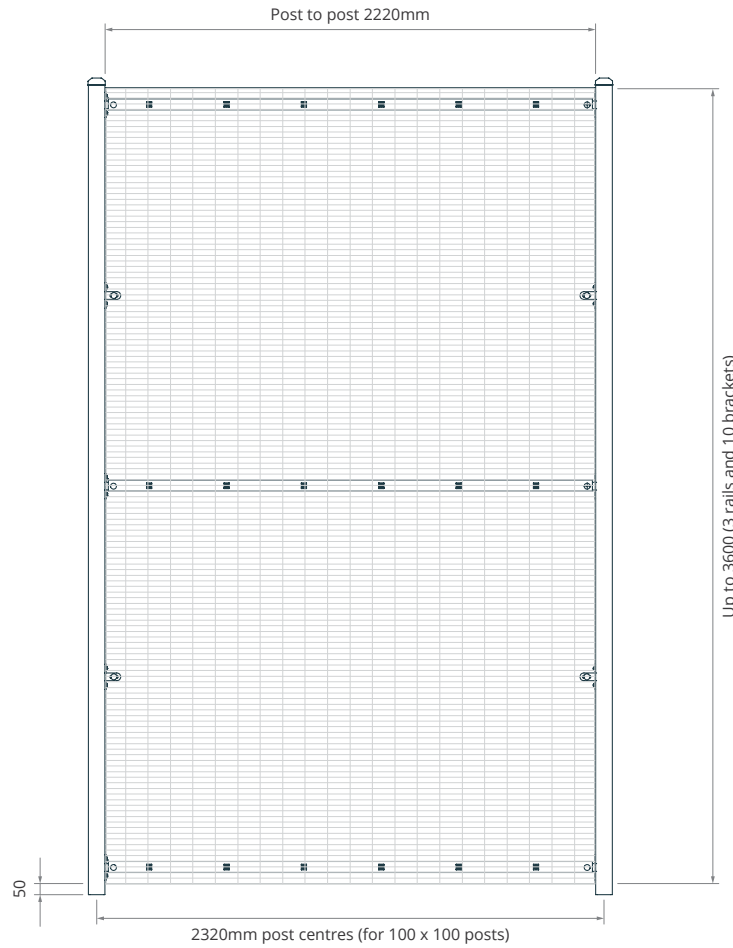

FLANGE POST

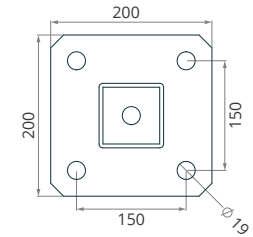

Post Size: SHS 100

Flange Thickness: 10mm

RAIL

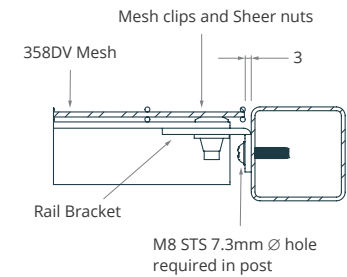

INGROUND POST

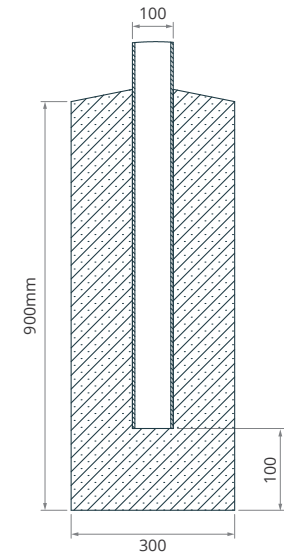

RAIL BRACKET

Bolt On

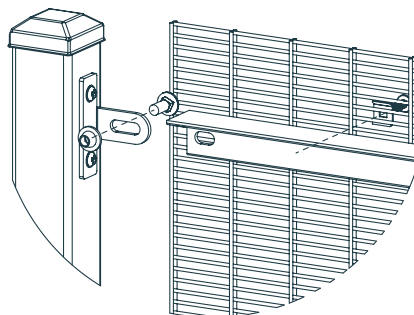
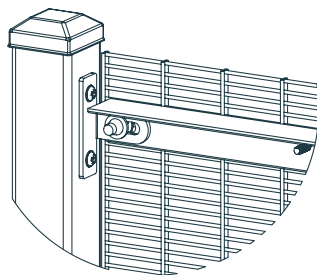

Weld On

